

Enphase IQ8, IQ8+, IQ8M, IQ8A, and IQ8H Microinverters with integrated MC4 connectors



FCC Compliance

This equipment has been tested and found to comply with the limits for a Class B digital device, pursuant to part 15 of the FCC rules. These limits are designed to provide reasonable protection against harmful interference in a residential installation. This equipment generates, uses and can radiate radio frequency energy and, if not installed and used in accordance with the instructions, may cause harmful interference to radio communications. However, there is no guarantee that interference will not occur in a particular installation. If this equipment does cause harmful interference to radio or television reception, which can be determined by turning the equipment off and on, you are encouraged to try to correct the interference by one or more of the following measures:

- Reorient or relocate the receiving antenna.
- Increase the separation between the equipment and the receiver.
- Connect the equipment into an outlet on a circuit different from that to which the receiver is connected.
- Consult the dealer or an experienced radio/TV technician for help.

Changes or modifications not expressly approved by the party responsible for compliance may void the user's authority to operate the equipment.

Other Information

Product information is subject to change without notice. All trademarks are recognized as the property of their respective owners.

User documentation is updated frequently; check the Enphase website (enphase.com/support) for the latest information.

To ensure optimal reliability and to meet warranty requirements, the Enphase Microinverter must be installed according to the instructions in this manual. For warranty text refer to enphase.com/warranty.

For Enphase patent information refer to enphase.com/company/patents/.

© 2022 Enphase Energy Inc. All rights reserved. Enphase, the Enphase logo, IQ8, IQ8+, IQ8M, IQ8A, IQ8H, IQ Gateway, IQ Combiner, IQ Microinverter, Installer App, Enphase App and other trademarks or service names are the trademarks of Enphase Energy, Inc. Data subject to change.

Audience

This manual is intended for use by professional installation and maintenance personnel.

Contents

Important Safety Information	5
Read this First	5
Product Labels	5
Safety and Advisory Symbols	5
IQ8 Microinverter Safety Instruction	5
PV Rapid Shutdown Equipment (PVRSE)	8
The Enphase IQ System	9
How the Enphase IQ Series Microinverters Work	10
System Monitoring	10
Optimal Reliability	10
Ease of Design	10
Planning for Microinverter Installation	11
Compatibility	11
Grounding Considerations	11
Branch Circuit Capacity	11
Utility Service Requirements	12
Wire Lengths and Voltage Rise	12
Lightning and Surge Suppression	12
Parts and Tools Required	13
Enphase Equipment	13
Other Items	13
Enphase Microinverter Installation	14
Step 1: Position the Enphase IQ Cable	14
Step 2: Position the Junction Box	15
Step 3: Mount the Microinverters	15
Step 4: Create an Installation Map	16
Step 5: Manage the Cabling	16
Step 6: Connect the Microinverters	17
Step 7: Terminate the Unused End of the Cable	17
Step 8: Complete Installation of the Junction Box	18
Step 9: Connect the PV Modules	18
Step 10: Enphase Energy System Configurations	18
Troubleshooting	23
Status LED Indications and Error Reporting	23
LED Operation	23
DC Resistance Low – Power Off Condition	23
Other Faults	24
Troubleshoot an Inoperable Microinverter	24
Disconnect a Microinverter	25
Install a Replacement Microinverter	25

Replacement Parts and Cabling	27
Enphase IQ Cable Planning and Ordering	27
Connector Spacing Options	27
Cabling Options	27
Enphase IQ Cable Accessories	27
Technical Data	28
Technical Considerations	28
Bifacial Modules	28
Specifications	29
IQ8-60-M-US Microinverter Specifications	29
IQ8PLUS-72-M-US Microinverter Specifications	31
IQ8M-72-M-US Microinverter Specifications	33
IQ8A-72-M-US Microinverter Specifications	35
IQ8H-240-72-M-US Microinverter Specifications	37
IQ8H-208-72-M-US Microinverter Specifications	39
IQ Cable Specifications	41
Enphase Connector Ratings	41
Enphase Installation Map	42
Sample Wiring Diagram	43

Important Safety Information

Read this First

This manual contains important instructions for use during installation and maintenance of the IQ8 Series Microinverters.

IMPORTANT: Enphase IQ Series Microinverters require the IQ Cable. An IQ Gateway is required to monitor performance of the IQ Microinverters. The IQ Accessories work only with Enphase IQ Series Microinverters.

Product Labels

The following symbols appear on the **product label** and are described here:



WARNING: Hot surface



DANGER: Refer to safety instructions



DANGER: Risk of electrical shock



Refer to manual



Double-Insulated

Safety and Advisory Symbols

To reduce the risk of electric shock, and to ensure the safe installation and operation of the Enphase IQ System, the following safety symbols appear throughout this document to indicate dangerous conditions and important safety instructions.

	DANGER:	This indicates a hazardous situation, which if not avoided, will result in death or serious injury.
	WARNING	This indicates a situation where failure to follow instructions may be a safety hazard or cause equipment malfunction. Use extreme caution and follow instructions carefully.
	WARNING:	This indicates a situation where failure to follow instructions may result in burn injury.
	NOTE:	This indicates information that is very important for optimal system operation. Follow instructions closely.







IQ8 Microinverter Safety Instruction

General Safety

	DANGER: Risk of electric shock. Risk of fire.	Only use electrical system components approved for wet locations.
		Only qualified personnel should install, troubleshoot, or replace Enphase Microinverters or Enphase IQ Cable and Accessories.
		Ensure that all AC and DC wiring is correct and that none of the AC or DC wires are pinched, shorted or damaged. Ensure that all AC junction boxes are properly closed.
	DANGER: Risk of electric shock.	Do not exceed the maximum number of microinverters in an AC branch circuit as listed in the manual. You must protect each microinverter AC branch circuit with a 20 A maximum breaker or fuse as appropriate.
		Do not use Enphase equipment in a manner not specified by the manufacturer. Doing so may cause death or injury to persons, or damage to equipment.

		<p>Be aware that installation of this equipment includes risk of electric shock.</p> <p>The DC conductors of this photovoltaic system are ungrounded and may be energized.</p> <p>Always de-energize the AC branch circuit before servicing. Never disconnect the DC or AC connectors under load.</p>
	<p>WARNINGS:</p>	<p>Before installing or using the Enphase Microinverter, read all instructions and cautionary markings in the technical description, on the Enphase equipment and on the photovoltaic (PV) equipment.</p> <p>Do not connect Enphase Microinverters to the grid or energize the AC circuit(s) until you have completed all of the installation procedures and have received approval from the electrical utility.</p> <p>When the PV array is exposed to light, DC voltage is supplied to the power conversion equipment (PCE).</p> <p>Risk of equipment damage. Enphase male and female connectors must only be mated with the identical type and brand of male/female connector.</p>
		<p>NOTES:</p> <p>To ensure optimal reliability and to meet warranty requirements, install the Enphase equipment according to the instructions in this manual.</p> <p>DANGER: Risk of electric shock. Always de-energize the AC branch circuit before servicing. Never disconnect the DC or AC connectors under load.</p> <p>Protection against lightning and resulting voltage surge must be in accordance with local standards.</p> <p>Perform all electrical installations in accordance with all applicable local electrical codes, such as: the Canadian Electrical Code, Part 1; ANSI requirements; and NPFA 70 (NEC).</p>

Microinverter Safety

	<p>WARNING: Risk of skin burn.</p>	<p>The chassis of the Enphase Microinverter is the heat sink. Under normal operating conditions, the temperature could be 20° C above ambient, but under extreme conditions the microinverter can reach a temperature of 90° C. To reduce risk of burns, use caution when working with microinverters.</p>
	<p>DANGER: Risk of fire.</p>	<p>The DC conductors of the PV module must be labeled “PV Wire” or “PV Cable” when paired with the Enphase Microinverter.</p>
	<p>DANGER: Risk of electric shock. Risk of fire.</p>	<p>Only qualified personnel may connect the Enphase Microinverter to the utility grid.</p> <p>Do not attempt to repair the Enphase Microinverter; it contains no user-serviceable parts. If it fails, contact Enphase customer service to obtain a return merchandise authorization (RMA) number and start the replacement process. Tampering with or opening the Enphase Microinverter will void the warranty.</p>
	<p>WARNING: Risk of equipment damage.</p>	<p>Install the microinverter under the PV module to avoid direct exposure to rain, UV, and other harmful weather events. Always install the microinverter bracket side up. Do not mount the microinverter upside down. Do not expose the AC or DC connectors (on the Enphase IQ Cable, PV module, or the microinverter) to rain or condensation before the connectors are mated.</p> <p>The maximum open circuit voltage of the PV module must not exceed the specified maximum input DC voltage of the Enphase Microinverter. Refer to the Enphase Compatibility Calculator at: https://enphase.com/en-us/support/module-compatibility to verify PV module electrical compatibility with microinverter. Use IQ8 Series microinverters only with compatible PV modules as per Enphase Compatibility Calculator. Using electrically incompatible PV module voids Enphase warranty.</p>
	<p>WARNING: Risk of equipment damage.</p>	<p>You must match the DC operating voltage range of the PV module with the allowable input voltage range of the Enphase Microinverter.</p> <p>The Enphase Microinverter is not protected from damage due to moisture trapped in cabling systems. Never mate microinverters to cables that have been left disconnected and exposed to wet conditions. This voids the Enphase warranty.</p>
	<p>WARNING: Risk of equipment damage.</p>	<p>The Enphase Microinverter functions only with a standard, compatible PV module with appropriate fill-factor, voltage, and current ratings. Unsupported devices include smart PV modules, fuel cells, wind or water turbines, DC generators, and non-Enphase batteries. These devices do not behave like standard PV modules, so operation and compliance are not guaranteed. These devices may also damage the Enphase Microinverter by exceeding its electrical rating, making the system potentially unsafe.</p>



NOTES:

The Enphase Microinverter has adjustable voltage and frequency trip points that may need to be set, depending upon local requirements. Contact [Enphase Customer Support](#) for required modifications as per local requirements.

Enphase IQ Cable Safety



DANGER: Risk of electric shock.

Do not install the Enphase IQ Cable terminator while power is connected.



WARNING: Risk of electric shock. Risk of fire.

When stripping the sheath from the IQ Cable, make sure the conductors are not damaged. If the exposed wires are damaged, the system may not function properly.

Do not leave AC connectors on the IQ Cable uncovered for an extended period. You must cover any unused connector with a sealing cap.

Make sure protective sealing caps have been installed on all unused AC connectors. Unused AC connectors are live when the system is energized.



WARNING:

Use the terminator only once. If you open the terminator following installation, the latching mechanism is destroyed. If the latching mechanism is defective, do not use the terminator. Do not circumvent or manipulate the latching mechanism.

When installing the Enphase IQ Cable, secure any loose cable to minimize tripping hazard.



NOTES:

When looping the Enphase IQ Cable, do not form loops smaller than 4.75" (12 cm) in diameter.

Provide support for the Enphase IQ-Cable every 1.8 m (6 ft).

If you need to remove a sealing cap, you must use the Enphase disconnect tool.

When installing the Enphase IQ Cable and accessories, adhere to the following:

- Do not expose the terminator cap or cable connections to directed, pressurized liquid (water jets, etc.).
- Do not expose the terminator or cable to continuous immersion.
- Do not expose the terminator cap or cable connections to continuous tension (e.g., tension due to pulling or bending the cable near the connection).
- Use only the connectors provided.
- Do not allow contamination or debris in the connectors.
- Use the terminator cap and cable connections only when all parts are present and intact.
- Do not install or use in potentially explosive environments.
- Do not allow the terminator to come into contact with open flame.
- Fit the terminator cap using only the prescribed tools and in the prescribed manner.
- Use the terminator to seal the conductor end of the Enphase IQ Cable; no other method is allowed.

PV Rapid Shutdown Equipment (PVRSE)

This product is UL Listed as PV Rapid Shutdown Equipment and conforms with NEC-2014, NEC-2017 and NEC-2020 section 690.12, and C22.1-2018 Rule 64-218 Rapid Shutdown of PV Systems, for AC and DC conductors, when installed according to the following requirements:

- Microinverters and all DC connections must be installed inside the array boundary. Enphase further requires that the microinverters and DC connections be installed under the PV module to avoid direct exposure to rain, UV, and other harmful weather events.
- The array boundary is defined as 305 mm (1 ft.) from the array in all directions, or 1 m (3 ft.) from the point of entry inside a building.

This Rapid shutdown system must be provided with an initiating device or status indicator, installed in a location accessible to first responders. Alternately it must be connected to an automatic system that initiates rapid shutdown in the event a system disconnects or other emergency system is activated.

The initiator shall be listed and identified as a disconnecting means that plainly indicates whether it is in the “off” or “on” position.

Examples are:

- Service disconnecting means
- PV system disconnecting means
- Readily accessible switch or circuit breaker

The handle position of a switch or circuit breaker is suitable for use as an indicator. Refer to NEC or CSA C22.1-2018 for more information.

Additionally, in a prominent location near the initiator device, a placard or label must be provided with a permanent marking including the following wording:

'PHOTOVOLTAIC SYSTEM EQUIPPED WITH RAPID SHUTDOWN' The term 'PHOTOVOLTAIC' may be replaced with 'PV.'

The placard, label, or directory shall be reflective, with all letters capitalized and having a minimum height of 9.5 mm (3/8") in white on red background.

The Enphase IQ System

The Enphase IQ System includes:

- **Enphase IQ8, IQ8+, IQ8M, IQ8A and IQ8H Microinverters:** The smart, grid-ready microinverters that convert the DC output of the PV module into grid-compliant AC power.
- **Enphase IQ Gateway (ENV-IQ-AM1-240):** The Enphase IQ Gateway is a communication device that provides network access to the PV array. The IQ Gateway collects production and performance data from the Enphase IQ Microinverters over on-site AC power lines and transmits the data to Enphase through an internet or cellular modem connection. The IQ Gateway is capable of monitoring up to 600 Enphase IQ Microinverters and up to 39 Enphase IQ Batteries. For details, refer to *Enphase IQ Gateway Installation and Operations Manual*.



NOTE: All 208 VAC installations require that you use the Enphase IQ Gateway to commission the Enphase Microinverters to propagate correct grid profile settings for 208 VAC trip points.

- **Enphase Installer Platform** web-based monitoring and management software: Installers can use the Enphase Installer Platform to view detailed performance data, manage multiple PV systems, and remotely resolve issues that might impact system performance. Find out more at enphase.com/enlighten.
- **Enphase Installer App** for iOS and Android devices: It allows installers to configure the system while onsite, eliminating the need for a laptop and improving installation efficiency. You can use the app to:
 - Connect to the IQ Gateway over a wireless network for faster system setup and verification
 - View and email a summary report that confirms a successful installation
 - Scan device serial numbers and sync system information with the Enphase installer platform
- **Enphase IQ Battery**
- **Enphase Field Wireable connectors (Q-CONN-10F and Q-CONN-10M):** Make connections from any IQ Cable, or open Field Wireable connector.

This manual describes the safe installation and operation of the Enphase Microinverter.



NOTE: To ensure optimal reliability and to meet warranty requirements, the Enphase Microinverter must be installed according to the instructions in this manual.

How the Enphase IQ Series Microinverters Work

The Enphase Microinverter maximizes energy production by using a sophisticated Maximum Power Point Tracking (MPPT) algorithm. Each Enphase Microinverter individually connects to one PV module in your array. This configuration enables an individual MPPT to control each PV module, ensuring that maximum power available from each PV module is exported to the utility grid regardless of the performance of the other PV modules in the array. While an individual PV module in the array may be affected by shading, soiling, orientation, or PV module mismatch, each Enphase Microinverter ensures top performance for its associated PV module.

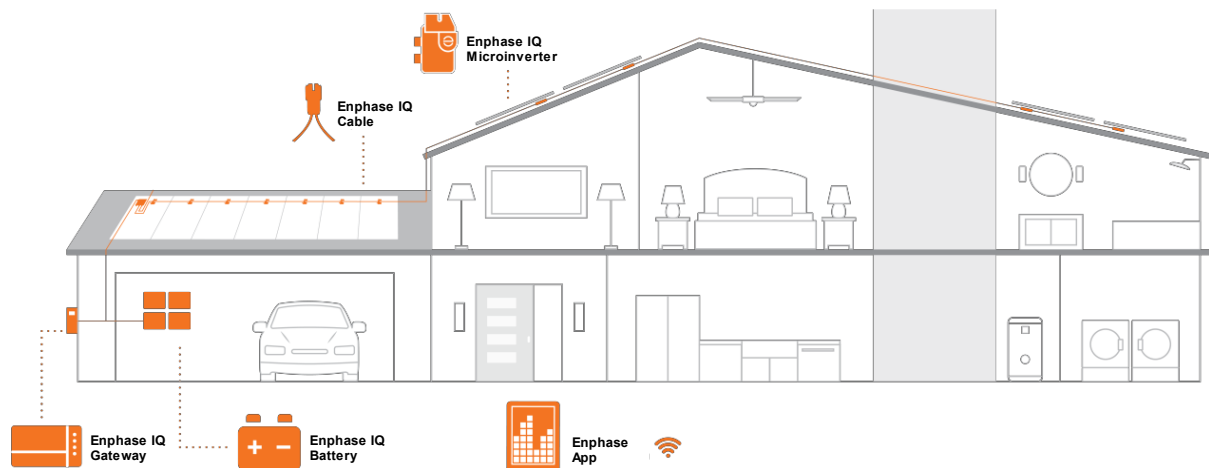

System Monitoring

Once you install the Enphase IQ Gateway and provide an internet connection through a broadband router or modem, the Enphase IQ Microinverters automatically begin reporting to the Enphase Installer Platform. The Enphase Installer Platform presents current and historical system performance trends and informs you of PV system status.

Optimal Reliability

Microinverter systems are inherently more reliable than traditional inverters. The distributed nature of a microinverter system ensures that there is no single point of system failure in the PV system. Enphase Microinverters are designed to operate at full power at ambient temperatures as high as 60°C (140°F).

Ease of Design

PV systems using Enphase Microinverters are very simple to design and install. You will not need string calculations or cumbersome traditional inverters. You can install individual PV modules in any combination of PV module quantity, type, age, and orientation. Each microinverter quickly mounts on the PV racking, directly beneath each PV module. Low voltage DC wires connect from the PV module directly to the co-located microinverter, eliminating the risk of personnel exposure to dangerously high DC voltage.

Planning for Microinverter Installation

The Enphase IQ8 Microinverter is compatible with 60-cell PV modules, and the IQ8+, IQ8M, IQ8A and IQ8H Microinverter support PV modules with 60-, 66-, or 72-cell PV modules. All of them install quickly and easily. The microinverter housing is designed for outdoor installation and complies with the NEMA 250, type 6 environmental enclosure rating standard.



NEMA 6 rating definition: Indoor or outdoor use primarily to provide a degree of protection against hose-directed water, the entry of water during occasional temporary submersion at a limited depth, and damage from external ice formation.

The Enphase IQ Cable is available with connector spacing options to accommodate installation of PV modules in portrait or landscape orientation. For Enphase IQ Cable ordering information, see “Enphase IQ Cable Planning and Ordering” on page 28.

Compatibility

The Enphase IQ Series Microinverters are **electrically compatible** with PV modules as listed in the following table. For specifications, see “Technical Data” on page 30 of this manual. You can refer to the Enphase Compatibility Calculator at: enphase.com/en-us/support/module-compatibility to verify PV module electrical compatibility. To ensure **mechanical compatibility**, be sure to order the correct connector type for both microinverter and PV module from your distributor.



WARNING: Risk of fire. The PV module DC conductors must be labeled “PV Wire” or “PV Cable” to comply with NEC for Ungrounded PV Power Systems.

Microinverter Model	Connector Type	PV Module Cell Count
IQ8-60-M-US	Stäubli MC4	Pair with 60 cell /120-half-cell modules
IQ8PLUS-72-M-US		Pair with 54-cell/108 half-cell, 60 cell / 120-half-cell, 66 cell, or 72 cell / 144-half-cell
IQ8M-72-M-US		
IQ8A-72-M-US		
IQ8H-240-72-M-US		
IQ8H-208-72-M-US		

Grounding Considerations

The Enphase Microinverter models listed in this guide do not require grounding electrode conductors (GEC), equipment grounding conductors (EGC), or grounded conductor (neutral). Your Authority Having Jurisdiction (AHJ) may require you to bond the mounting bracket to the racking. If so, use UL2703 hardware or star washers. The microinverter itself has a Class II double-insulated rating, which includes ground fault protection (GFP). To support GFP, use only PV modules equipped with DC cables labeled “PV Wire” or “PV Cable.”

Branch Circuit Capacity

Plan your AC branch circuits to meet the following limits for maximum number of microinverters per branch when protected with a 20 amp (maximum) over current protection device (OCPD).

Maximum* IQ8 Micros per AC branch circuit (240 VAC)	Maximum* IQ8+ Micros per AC branch circuit (240 VAC)	Maximum* IQ8M Micros per AC branch circuit (240 VAC)
16	13	11
Maximum* IQ8A Micros per AC branch circuit (240 VAC)	Maximum* IQ8H Micros per AC branch circuit (240 VAC)	Maximum* IQ8H Micros per AC branch circuit (208 VAC)
11	10	9



NOTE: *Limits may vary. Refer to local requirements to define the number of microinverters per branch in your area.

Utility Service Requirements

The Enphase IQ Series Microinverters work with single-phase service. Measure AC line voltages at the electrical utility connection to confirm that it is within the ranges shown:

240 Volt AC, Single Phase	
L1 to L2	211 to 264 VAC
L1, L2 to ground	106 to 132 VAC
208 Volt AC, Single Phase	
L1 to L2	183 to 229 VAC
L1, L2 to ground	106 to 132 VAC



NOTE: All 208 VAC installations require that you use the Enphase IQ Gateway to commission the Enphase Microinverters to propagate correct grid profile settings for 208 VAC trip points.

Wire Lengths and Voltage Rise

When planning the system, you must select the appropriate AC conductor size to minimize voltage rise. Select the correct wire size based on the distance from the beginning of the microinverter AC branch circuit to the breaker in the load center. Enphase recommends a voltage rise total of less than 2% for the sections from the microinverter AC branch circuit to the breaker in the load center.

Enphase provides guidance about choosing wire size and maximum conductor lengths in the Voltage Rise Technical Brief at enphase.com/support. Refer to this brief for voltage rise values in Enphase IQ Cables and on how to calculate voltage rise in other wire sections of the system.

Standard guidelines for voltage rise on feeder and AC branch circuit conductors might not be sufficient for microinverter AC branch circuits that contain the maximum allowable microinverters. This is due to high inherent voltage rise on the AC branch circuit.



Best practice: Center-feed the branch circuit to minimize voltage rise in a fully populated branch. This practice greatly reduces the voltage rise as compared with an end-fed branch. To center-feed a branch, divide the circuit into two sub-branch circuits protected by a single OCPD.

Lightning and Surge Suppression

Enphase Microinverters have integral surge protection, greater than most traditional inverters. However, if the surge has sufficient energy, the protection built into the microinverter can be exceeded, and the equipment can be damaged. For this reason, Enphase recommends that you protect your system with a lightning and/or surge suppression device. In addition to having some level of surge suppression, it is also important to have insurance that protects against lightning and electrical surges. Enphase has tested the following devices:

- [Leviton 51110-SRG](#)
- [Schneider SquareD HEPD50](#)



NOTE: Protection against lightning and resulting voltage surge must be in accordance with local standards.

Parts and Tools Required

In addition to the microinverters, PV modules, and racking, you will need the following:

Enphase Equipment

- **Enphase IQ Gateway:** Required to monitor production. IQ Gateway (model ENV-IQ-AM1-240) communications gateway or IQ Combiner (model X-IQ-AM1-240-B, X-IQ-AM1-240-2, X-IQ-AM1-240-3, X-IQ-AM1-240-3C).
- **Enphase Installer App:** Download the Enphase Installer app, open it, and log in to your Enphase Installer Platform account. Use it later to scan microinverter serial numbers and connect to the IQ Gateway to track system installation progress. To download, go to enphase.com/toolkit or scan the QR code at right.
- **Tie wraps or IQ Cable Clips** (Q-CLIP-100)
- **Enphase Sealing Caps** (Q-SEAL-10) for any unused drops on the Enphase IQ Cable.
- **Enphase Terminator** (Q-TERM-10) typically two needed per branch circuit.
- **Enphase Disconnect Tool** (Q-DISC-10)
- **Enphase Field Wireable Connectors** (male and female: Q-CONN-10M and Q-CONN-10F)
- **Enphase IQ Cable:**



Cable Model	Connector Spacing	PV Module Orientation	Connector Count per box
Q-12-10-240	1.3m	Portrait	240
Q-12-17-240	2.0m	Landscape (60-cell)	240
Q-12-20-200	2.3m	Landscape (72-cell)	200

Other Items

- AC junction box
- Number 2 and 3 screwdrivers
- Wire cutters, voltmeter
- Torque wrench, sockets, wrenches for mounting hardware

Enphase Microinverter Installation

Installing the Enphase IQ Series Microinverters involves several key steps. Each step listed here is detailed in the following pages.

- Step 1:** Position the Enphase IQ Cable
- Step 2:** Position the Junction Box
- Step 3:** Mount the Microinverters
- Step 4:** Create an Installation Map
- Step 5:** Manage the Cabling
- Step 6:** Connect the Microinverters
- Step 7:** Terminate the Unused End of the Cable
- Step 8:** Complete Installation of the Junction Box
- Step 9:** Connect the PV Modules
- Step 10:** Energize the System

Horizontal Mount

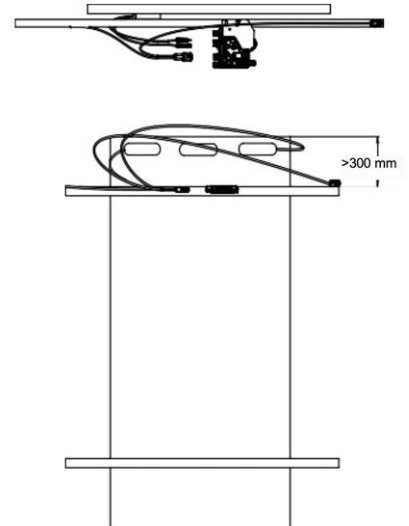
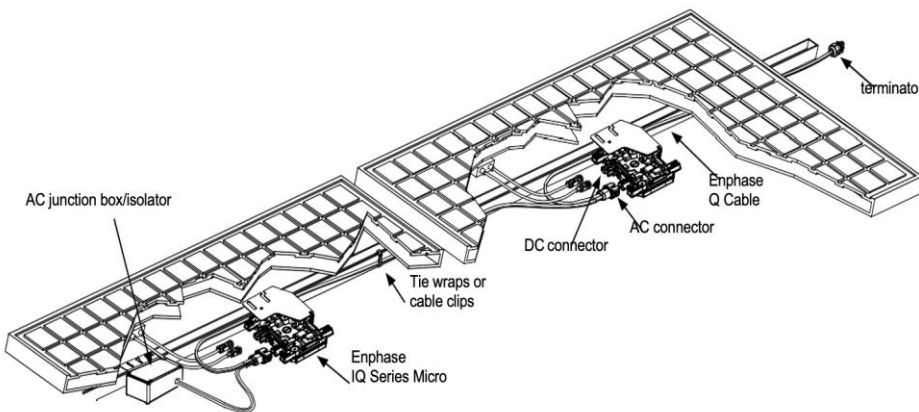

Vertical Mount

Step 1: Position the Enphase IQ Cable

- A. Plan each cable segment to allow drop connectors on the Enphase IQ Cable to align with each PV module. Allow extra length for slack, cable turns, and any obstructions.
- B. Mark the approximate centers of each PV module on the PV racking.
- C. Lay out the cabling along the installed racking for the AC branch circuit.
- D. Cut each segment of cable to meet your planned needs.



WARNING: When transitioning between rows, secure the cable to the rail to prevent cable damage or connector damage. Do not count on connector to withstand tension.

Step 2: Position the Junction Box

- A. Verify that AC voltage at the site is within range.

Service Type and Voltage: L1-L2	
240 VAC Split-Phase	211 to 264 VAC
208 VAC Single-Phase	183 to 229 VAC



NOTE: All 208 VAC installations require that you use the Enphase IQ Gateway to commission the Enphase Microinverters to propagate correct grid profile settings for 208 VAC trip points.

- B. Install a junction box at a suitable location on the racking.
 C. Provide an AC connection from the junction box back to the electricity network using equipment and practices as required by local jurisdictions.

Step 3: Mount the Microinverters

- A. Mount the microinverter horizontally bracket side up or vertically
- Always place the microinverter under the PV module, protected from direct exposure to rain, sun, and other harmful weather events. Allow a minimum of 1.9 cm (3/4") between the roof and the microinverter. Also allow 1.3 cm (1/2") between the back of the PV module and the top of the microinverter.
 - For vertical mount, also maintain > 30 cm (12") clearance from the edges of the PV module to protect the microinverter from direct exposure to rain, UV, and other harmful weather events.



WARNING: Install the microinverter under the PV module to avoid direct exposure to rain, UV, and other harmful weather events. Do not mount the microinverter upside down.

- B. Torque the microinverter fasteners as follows. Do not over torque.
- 6 mm (1/4") mounting hardware: 5 Nm (45 to 50 in-lbs.)
 - 8 mm (5/16") mounting hardware: 9 Nm (80 to 85 in-lbs.)
 - When using UL 2703 mounting hardware, use the manufacturer's recommended torque value

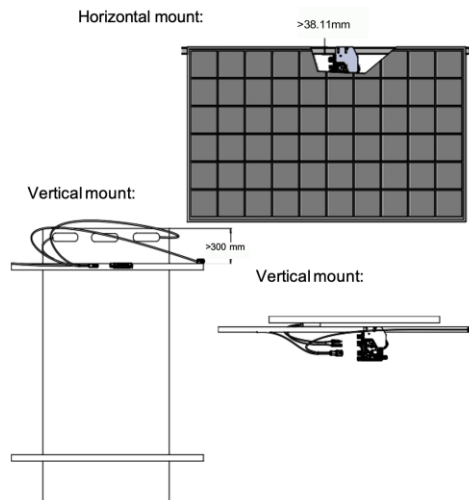

Step 4: Create an Installation Map

The Enphase Installation Map is a diagram of the physical location of each microinverter in your PV installation. Copy or use the blank map on page 44 to record microinverter placement for the system or provide your own layout if you require a larger or more intricate installation map.

Each Enphase Microinverter, IQ Gateway, and IQ Battery has a removable serial number label. Build the installation map by peeling the serial number labels from the microinverter mounting plates and placing the labels on the map. You will also place the Enphase IQ Gateway and IQ Battery serial number on the map after installation.

After you have created the installation map, use the Enphase Installer App mobile app to record serial numbers and configure the system.

For details, refer to “Detect the Microinverters” in the help topics of the Enphase Installer app.

- A. Peel the removable serial number label from each microinverter and affix it to the respective location on the paper installation map.
- B. Peel the label from the IQ Gateway and any Enphase IQ Battery, (if installed) and affix it to the installation map.
- C. Always keep a copy of the installation map for your records.

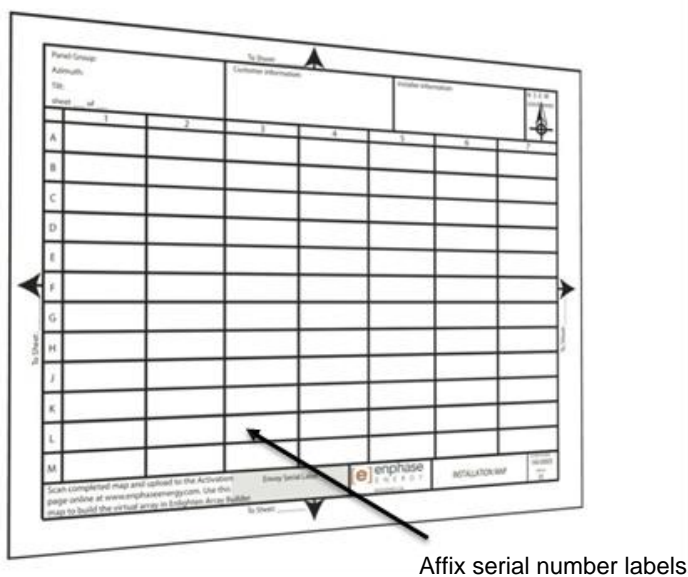

Step 5: Manage the Cabling

- A. Use cable clips or tie wraps to attach the cable to the racking. Leave no more than 1.8 m (6 ft) between cable clips or tie wraps.

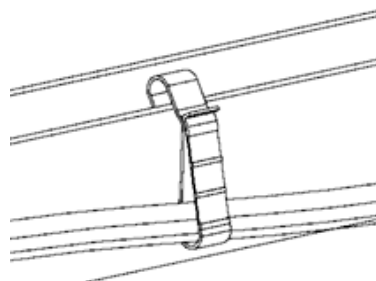

Cable clip

- B. Dress any excess cabling in loops so that it does not contact the roof. Do not form loops smaller than 12 cm (4¾”) in diameter.



WARNING: Tripping Hazard. Loose cables can become a tripping hazard. Dress the Enphase IQ Cable to minimize this potential.

Step 6: Connect the Microinverters

- A. Connect the microinverter. Listen for a click as the connectors engage.
- B. Cover any unused connector with Enphase Sealing Caps. Listen for a click as the connectors engage.

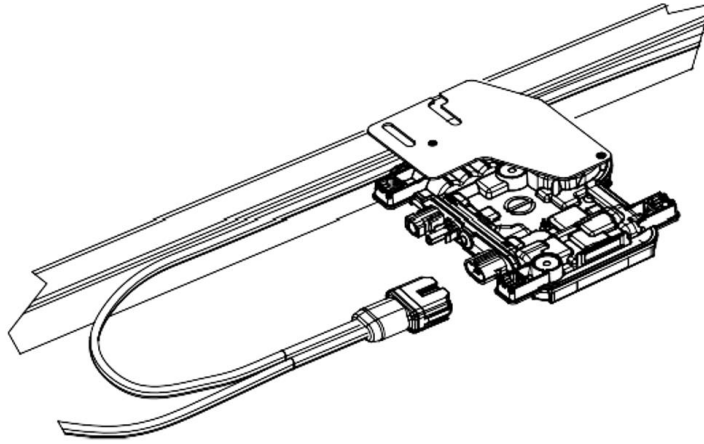

WARNING: Risk of electric shock. Risk of fire. Install sealing caps on all unused AC connectors as these connectors become live when the system is energized. Sealing caps are required for protection against moisture ingress.



NOTE: If you need to remove a sealing cap, you must use the Enphase Disconnect Tool. See “Disconnect a Microinverter” on page 25.

Step 7: Terminate the Unused End of the Cable

Terminate the unused end of the Enphase IQ Cable as follows.

- A. Remove 13 mm ($\frac{1}{2}$ inch) of the cable sheath from the conductors. Use the terminator loop to measure 13 mm.
- B. Slide the hex nut onto the cable. There is a grommet inside of the hex nut that should remain in place.
- C. Insert the cable into the terminator body so that each of the two wires land on opposite sides of the internal separator.

Terminator Body

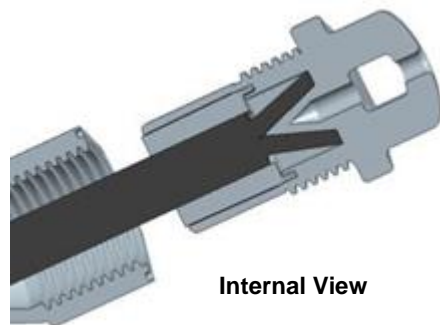
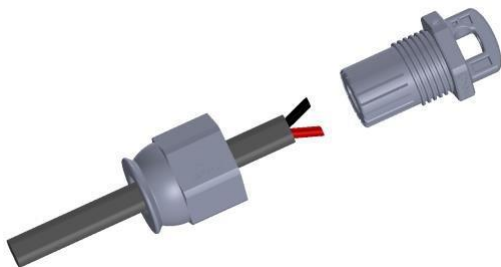

Internal View

- D. Insert a screwdriver into the slot on the top of the terminator to hold it in place and torque the nut to 7 Nm.

- E. Hold the terminator body stationary with the screwdriver and turn only the hex nut to prevent the conductors from twisting out of the separator.



NOTE: Turn only the hex nut to prevent conductors from twisting out of the separator.

- F. Attach the terminated cable end to the PV racking with a cable clip or tie wrap so that the cable and terminator do not touch the roof.



WARNING: The terminator cannot be re-used. If you unscrew the nut, you must discard the terminator.



Step 8: Complete Installation of the Junction Box

- A. Connect the Enphase IQ Cable into the junction box.
- B. Refer to the wiring diagrams on page 45 for more information. Wire colors are listed in the following table.

Wire Colors	
L1-Black	L2-Red

Step 9: Connect the PV Modules



WARNING: Electrical shock hazard. The DC conductors of this photovoltaic system are ungrounded and may be energized.

- A. If required, attach the Enphase DC bulkhead adaptors to the microinverters. Make sure they are fully seated. **Do not reverse the adaptor connections.**
- B. Connect the DC leads of each PV module to the DC input connectors of the corresponding microinverter.
- C. Check the LED on the connector side of the microinverter. The LED flashes six times when DC power is applied.
- D. Mount the PV modules above the microinverters.

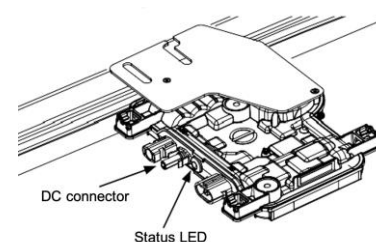

Step 10: Enphase Energy System Configurations

Following are common system configurations possible with Enphase Energy System using IQ8 PV (IQ8/ IQ8+ /IQ8M /IQ8A /IQ8H) Microinverters.

- PV Solar Grid Tied
- PV Solar Grid Agnostic
- PV Solar + Storage
- PV Solar + Generator
- PV Solar + Storage + Generator

Based on System configuration Enphase Energy system technology systems include following Enphase products -

- **Enphase IQ Battery system** is an all-in-one AC coupled storage system that includes embedded, grid-forming multimode microinverters. You can connect multiple IQ Battery systems to maximize potential backup for homes. The IQ Battery 3 storage system provides flexibility to customers to start small and add capacity incrementally.

- **Enphase IQ System Controller R2:** The Enphase Energy System includes the IQ System Controller with Microgrid Interconnection Device (MID) capability, which consolidates interconnection equipment into a single enclosure and streamlines grid-independent capabilities of PV and storage installations by providing a consistent, pre-wired solution for residential applications. Along with MID functions, it includes PV, storage, and generator input circuits. It allows IQ Battery storage systems to form an intentional island (per IEEE 1547.4 definition) and contains a neutral-forming transformer (NFT) to enable 120/240 V operation in backup mode.
- **Enphase Wireless communication kit** enables direct communication between IQ Battery, IQ System Controller, and the Gateway using 2.4 GHz frequency. The kit is connected to one of the USB ports on the IQ Gateway.
- **An Enphase Mobile Connect** cellular modem is required unless already present to ensure the best performance of your system. The cellular modem connects to a USB port on the IQ Gateway.
- For new or retrofit systems with IQ-Series solar microinverters:
 - **IQ8 PV (IQ8/ IQ8+ /IQ8M /IQ8A /IQ8H) Series Microinverters and accessories.** Enphase Energy System technology is fully compatible with IQ8 Series Microinverters
 - **IQ Gateway**, a communications gateway that can communicate with IQ8 series Microinverters, IQ batteries, and the IQ System Controller smart switch. It collects system performance information and transmits that information over the internet to Enphase’s cloud. An IQ Gateway is required for Enphase Energy Systems with IQ-Series microinverters. Note the IQ Gateway is included in an Enphase IQ Combiner.
 - **IQ Combiner series** consolidates interconnection equipment into a single enclosure and streamlines PV and storage installations by providing a consistent, pre-wired solution for residential applications. It includes the Enphase IQ Gateway. Install the new communication kit in any IQ Combiner to enable wireless communication with Enphase IQ Battery and IQ System Controller

Enphase Energy System PV Solar Grid Tied:

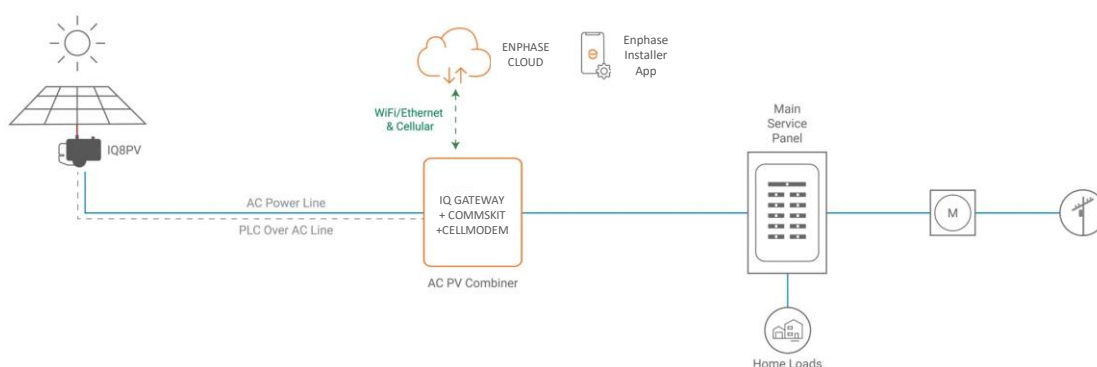

For Grid Tied mode, post IQ8 PV Microinverter installations energize the system:

- Turn ON the AC disconnect or circuit breaker for the branch circuit.
- Turn ON the main utility-grid AC circuit breaker. Your system starts producing power **after a five-minute wait time.**
- Check the LED on the connector side of the microinverter:

LED Color	Indicates
Flashing green	Normal operation. AC grid function is normal and there is communication with the IQ Gateway
Flashing orange	The AC grid is normal but there is no communication with the IQ Gateway
Flashing Red	The AC grid is either not present or not within specification
Solid Red	There is an active “DC Resistance Low, Power Off Condition.” To reset, see “DC Resistance Low – Power Off Condition” on page 23.

Refer to the Enphase IQ Gateway Quick Install Guide to install the IQ Gateway and set up system monitoring and grid management functions.

Enphase Energy System PV Solar Grid Agnostic:

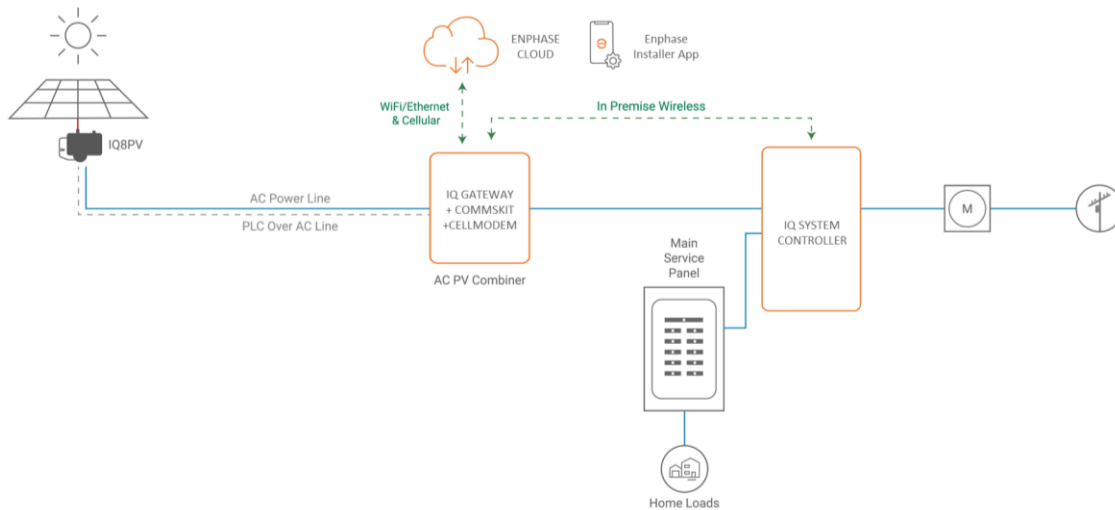

In the PV Solar Grid Agnostic configuration in Enphase Energy System, IQ Smart controller smart switch is installed on the line-side of the main load panels. This allows a properly sized Enphase Energy system to provide power to all loads in the main load panel in the event of a grid outage and PV solar presence. In this configuration, the IQ System Controller can be configured with a main breaker to act as the service disconnecting means. The PV system shall be interconnected to the IQ System Controller on a dedicated breaker. This configuration typically supports larger PV system sizes and may allow avoiding expensive utility service and/or main service panel upgrades.

System commissioning for grid agnostic configuration should be done with grip power present. During IQ8 PV installation, please ensure all relays are open from main panel and IQ System Controller. When commissioned, IQ System Controller gets powered on from grid side of the MID (Microgrid interconnect device); it closes the MID relay and PV relay. IQ8 PV shall start producing power in grid tied mode with IQ Gateway power on. Follow the Enphase Energy system commissioning process using Enphase Installer App for system commissioning.

Enphase Energy System PV Solar + Storage – Whole Home Backup Configuration:

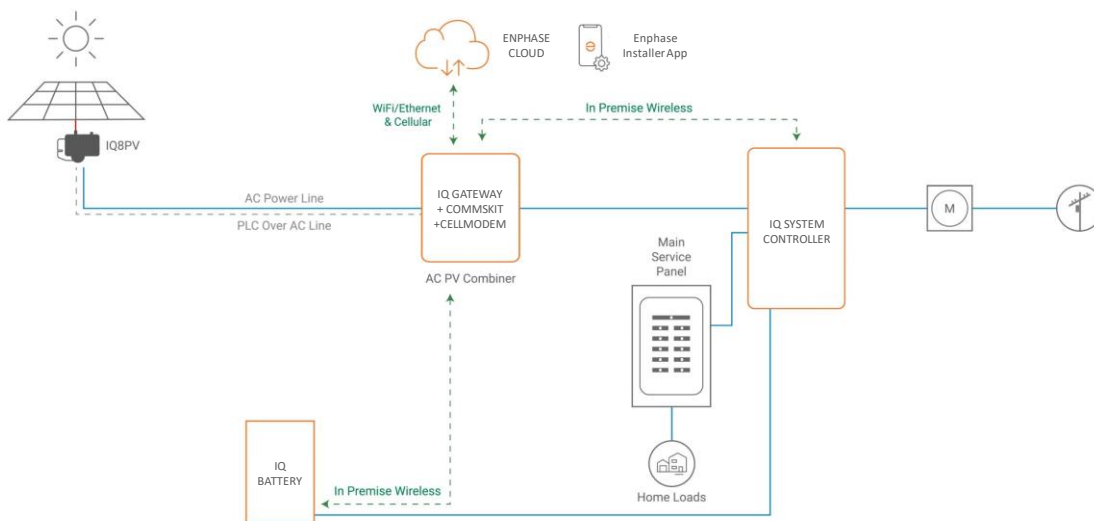

In the whole home (main load panel) backup configuration, IQ System Controller is installed on the line-side of the main load panels rated up to 200A. This allows a properly sized Enphase Energy System to provide power to all loads in the main load panel in the event of a grid outage. In this configuration, the IQ System Controller can be configured with a main breaker to act as the service disconnecting means. The PV system can be interconnected to the IQ System Controller on a dedicated breaker or may be interconnected to the main load panel. This configuration typically supports

larger PV and storage system sizes and may allow avoiding expensive utility service and/or main service panel upgrades.

The above configuration can also work with a genset connected to IQ System Controller with or without IQ Battery. Below two images explain the connection configuration.

Enphase Energy System PV Solar + Generator Configuration:

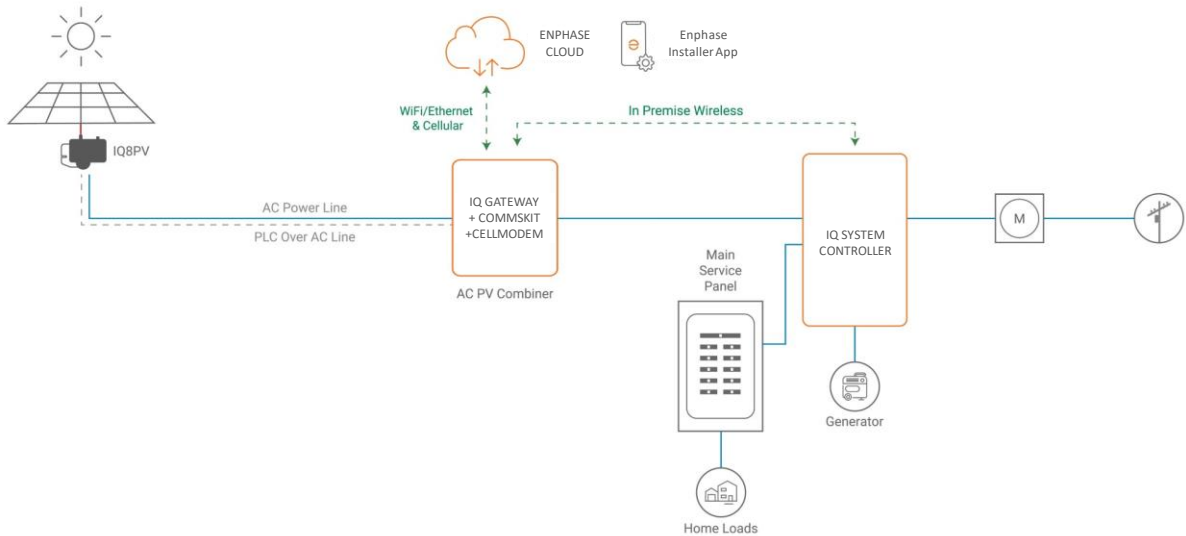

Enphase Energy System PV Solar + IQ Battery + Generator Configuration:

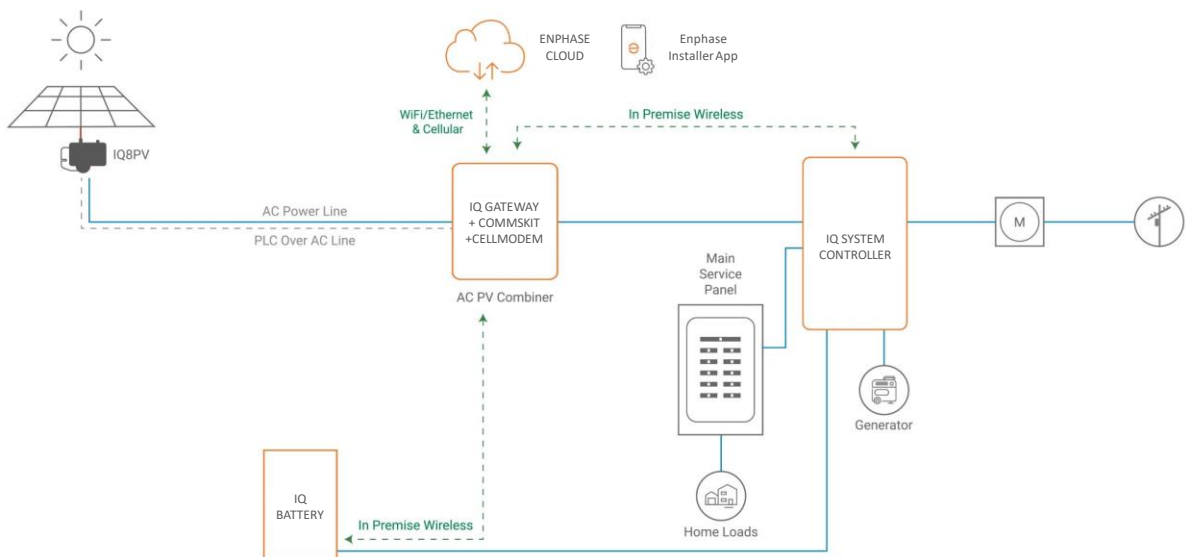

Set Up and Activate Monitoring

Refer to the Enphase IQ Gateway Quick Install Guide to install the IQ Gateway and set up system monitoring and grid management functions. This guide leads you through the following:

- Connecting the Gateway
- Detecting devices
- Connecting to Enphase Installer Platform
- Registering the system
- Building the virtual array



NOTE: When the utility requires a profile other than the default IEEE 1547 (for example grids managed by Hawaii Electric Industries [HEI] including HECO) you must select an appropriate grid profile for your installation.

You can set the grid profile through Enphase Installer Platform, during system registration, or through Enphase Installer App at any time. You must have an Enphase IQ Gateway to set or change the grid profile. For more information on setting or changing the grid profile, refer to the Enphase IQ Gateway Installation and Operation Manual at enphase.com/support.

Troubleshooting

Follow all the safety measures described throughout this manual. Qualified personnel can use the following troubleshooting steps if the PV system does not operate correctly.



WARNING: Risk of electric shock. Do not attempt to repair the Enphase Microinverter; it contains no user-serviceable parts. If it fails, contact Enphase Customer Support to obtain an RMA (return merchandise authorization) number and start the replacement process.

Status LED Indications and Error Reporting

The following section describes LED indications.

LED Operation

LED Color	Indicates
Flashing green	Normal operation. AC grid function is normal and there is communication with the IQ Gateway
Flashing orange	The AC grid is normal but there is no communication with the IQ Gateway
Flashing Red	The AC grid is either not present or not within specification
Solid Red	There is an active “DC Resistance Low, Power Off Condition.” To reset, see “DC Resistance Low – Power Off Condition” below.

The status LED on each microinverter lights green about six seconds after DC power is applied. It remains lit solid for two minutes, followed by six green blinks. After that, red blinks indicate that no grid is present if the system is not yet energized.

Any short red blinks after DC power is first applied to the microinverter indicate a failure during microinverter startup.

DC Resistance Low – Power Off Condition

For all **IQ Series models**, a solid red status LED when DC power has been cycled indicates the microinverter has detected a DC Resistance Low – Power Off event. The LED will remain red and the fault will continue to be reported by the Gateway until the error has been cleared.

An insulation resistance (IR) sensor in the microinverter measures the resistance between the positive and negative PV inputs to ground. If either resistance drops below a threshold, the microinverter stops power production and raises this condition. This may indicate defective module insulation, defective wiring or connectors, moisture ingress, or a similar problem. Although the cause may be temporary, this microinverter condition persists until the sensor is manually reset.

An IQ Gateway is required to clear this condition. The condition clears on operator command unless its cause is still present.

If a microinverter registers a “DC Resistance Low - Power Off” condition, you can attempt to clear this condition. If the condition does not clear after you perform the following procedure, contact Enphase Customer Support at enphase.com/en-us/support/contact.



There are two ways to send a clear message to the microinverter. Note that the condition will not clear after sensor reset if the cause of the failure is still present. If the condition persists, contact your installer.

Method 1: Clear this Error Using Enphase Installer Platform

- Log in to Enphase Installer Platform and access the system.
- Click the **Events** tab. The next screen shows a current “DC Resistance Low - Power Off” condition for the system.
- Click **DC Resistance Low - Power Off**.
- Where “n” is the number of affected devices, click **n devices (show details)**.
- Click the serial number of the affected microinverter.
- Click **Reset DC Resistance Low - Power Off Sensor**.
- The system displays, “A DC Resistance Low- Power Off reset task was issued on [date and time] for this microinverter and is still pending.”

Method 2: Use Enphase Installer App to Clear the Condition

On the list of detected microinverters, a green dot or red square appears to the left of each microinverter serial number. A green dot indicates Status OK. A red square indicates an event for that microinverter.

- Tap the  to the left of the serial number to view details for a microinverter event.
- If the microinverter status shows that there is an active **DC Resistance Low – Power Off** condition, tap the  to send the clear message to the affected microinverter. The app then indicates that a clear message was sent.

Other Faults

All other faults are reported to the Gateway. Refer to the *Enphase IQ Gateway Installation and Operation Manual* at enphase.com/support for troubleshooting procedures.

Troubleshoot an Inoperable Microinverter

To troubleshoot an inoperable microinverter, follow the steps in the order shown



WARNING: Risk of electric shock. Always de-energize the AC branch circuit before servicing. Never disconnect the DC connectors under load.



WARNING: The Enphase Microinverters are powered by DC power from the PV modules. Make sure you disconnect the DC connections and reconnect DC power and then watch for the solid green about six seconds after connection to DC power.

- Make sure AC breakers and disconnects are closed.
- Check the connection to the utility grid and verify that the utility voltage is within allowable ranges.
- Verify that AC line voltages at all solar power circuit breakers at the load center and subpanels are within the ranges shown in the following table.

240 Volt AC, Single Phase	
L1 to L2	211 to 264 VAC
L1, L2 to ground	106 to 132 VAC
208 Volt AC, Single Phase	
L1 to L2	183 to 229 VAC
L1, L2 to ground	106 to 132 VAC

- Using an Enphase Disconnect Tool, disconnect the AC cable for the microinverter in question from the Enphase IQ Cable.
- Verify that utility power is present at the microinverter by measuring line to line and line to ground at the Enphase IQ Cable connector.
- Visually check that the AC branch circuit connections (Enphase IQ Cable and AC connections) are properly seated. Reseat if necessary. Check also for damage, such as rodent damage.
- Make sure that any upstream AC disconnects, as well as the dedicated circuit breakers for each AC branch circuit, are functioning properly and are closed.
- Disconnect and re-connect the DC PV module connectors. The status LED of each microinverter will light solid green a few seconds after connection to DC power and then blink green six times to indicate normal start-up operation about two minutes after connecting to DC power. The LED subsequently resumes normal operation if the grid is present. See the table on the previous page outlining LED indicators for normal operation.
- Attach an ammeter clamp to one conductor of the DC cables from the PV module to measure microinverter current. This will be under one amp if AC is disconnected.

- J. Verify the PV module DC voltage is within the allowable range shown in “Specifications” on page 33 of this manual.
- K. Swap DC leads with a known good, adjacent PV module. If after checking Enphase Installer Platform periodically (this may take up to 30 minutes), the problem moves to the adjacent module, this indicates that the PV module isn't functioning correctly. If it stays in place, the problem is with the original microinverter. Contact [Enphase Customer Support](#) for help in reading the microinverter data and for help in obtaining a replacement microinverter, if needed.
- L. Check the DC connections between the microinverter and the PV module. The connection may need to be tightened or reseated. If the connection is worn or damaged, it may need replacement.
- M. Verify with your utility that line frequency is within range.
- N. If the problem persists, contact Customer Support at enphase.com/en-us/support/contact.

Disconnect a Microinverter

If problems remain after following the troubleshooting steps listed previously, contact Enphase at enphase.com/en-us/support/contact. If Enphase authorizes a replacement, follow the steps below. To ensure the microinverter is not disconnected from the PV modules under load, follow the disconnection steps in the order shown:

- A. De-energize the AC branch circuit breaker.
- B. Enphase AC connectors are tool-removable only. To disconnect the microinverter from the Enphase IQ Cable insert the disconnect tool and remove the connector.
- C. Cover the PV module with an opaque cover.
- D. Using a clamp-on meter, verify there is no current flowing in the DC wires between the PV module and the microinverter. If current is still flowing, check that you have completed steps one and two above.



NOTE: Take care when measuring DC current as most clamp-on meters must be zeroed first and tend to drift with time.

- E. Disconnect the PV module DC wire connectors from the microinverter using the Enphase Disconnect Tool.
- F. If present, loosen and/or remove any bonding hardware.
- G. Remove the microinverter from the PV racking.



WARNING: Risk of electric shock. Risk of fire. Do not leave any connectors on the PV system disconnected for an extended period. If you do not plan to replace the microinverter immediately, you must cover any unused connector with a sealing cap.



Install a Replacement Microinverter

- A. When the replacement microinverter is available, verify that the AC branch circuit breaker is de-energized.
- B. Mount the microinverter horizontally bracket side up or vertically
 - Always place the microinverter under the PV module, protected from direct exposure to rain, sun, and other harmful weather events. Allow a minimum of 1.9 cm (3/4") between the roof and the microinverter. Also allow 1.3 cm (1/2") between the back of the PV module and the top of the microinverter.
 - For vertical mount, also maintain > 30 cm (12") clearance from the edges of the PV module to protect the microinverter from direct exposure to rain, UV, and other harmful weather events.



WARNING: Risk of equipment damage. Mount the microinverter under the PV module.

- Install the microinverter under the PV module to avoid direct exposure to rain, UV, and other harmful weather events.
- Always install the microinverter bracket side up.
- Do not mount the microinverter upside down.

- Do not expose the AC or DC connectors (on the Enphase IQ Cable connection, PV module, or the microinverter) to rain or condensation before the connectors are mated.
- C. Torque the mounting fasteners to the values shown. Do not over torque.
- 6 mm (1/4") mounting hardware: 5 Nm (45 to 50 in-lbs.)
 - 8 mm (5/16") mounting hardware: 9 Nm (80 to 85 in-lbs.)
 - When using UL 2703 mounting hardware, use the manufacturer's recommended torque value
- D. If you are using bonding hardware, the old bonding hardware should be discarded, and new bonding hardware must be used when installing the replacement microinverter.
- E. Connect the microinverter to the IQ Cable connector. Listen for a click as connectors engage.
- F. Connect the DC leads of each PV module to the DC input connector of the microinverter.
- G. Re-mount the PV module above the microinverter.
- H. Energize the AC branch circuit breaker and verify operation of the replacement microinverter by checking the Status LED on the connector side of the microinverter.
- I. Use the Enphase Installer App to delete the old microinverter serial number from the Enphase IQ Gateway database. In Enphase Installer App, once connected to the IQ Gateway:
- a. Tap Micros > Manage.
 - b. Tap the checkbox  to the right of the microinverter serial number that you replaced.
 - c. Tap  to delete the microinverter from the IQ Gateway database.
- J. Add the new microinverter serial number to the Gateway database by initiating a device scan using one of the following methods:
- a. Method 1: Initiate a scan using the Enphase Installer App**
 - In Enphase Installer App, once connected to the IQ Gateway, navigate to the Overview screen.
 - From the Overview screen, tap Detected > Start Device Scan to start a new 30-minute device scan.
 - If device scanning on the IQ Gateway is inhibited, the app displays "Scan Inhibited." If you need to add more microinverters to the system when device scanning is inhibited on the IQ Gateway, you must use the Enphase Installer App scanning tool to provision them on the IQ Gateway, rather than using the IQ Gateway's device scanning function to discover them. If this is not possible and you need to enable device scanning on the IQ Gateway, contact Enphase Customer Support at enphase.com/en-us/support/contact.
 - b. Method 2: Use an IQ Gateway**
 - Press the **Device Scan** button on the IQ Gateway. The IQ Gateway begins a 15-minute scan to identify all of the microinverters deployed at the site. The Microinverter Communications LED  flashes green during the scan.



**Microinverter Communications LED
Device Scan button**

- K. Log in to Enphase Installer platform to use Enphase installer platform's Array Builder to add the newly detected microinverter to the virtual array.
- L. Ship the old microinverter to Enphase using the supplied return-shipping label.

Replacement Parts and Cabling

Enphase IQ Cable Planning and Ordering

The Enphase IQ Cable is a continuous length of 12 AWG, double insulated, outdoor-rated cable with integrated connectors for microinverters. These connectors are preinstalled along the IQ Cable at intervals to accommodate varying PV module widths. The microinverters plug directly into the cable connectors.

The cabling is compatible with a variety of PV racking systems. For a list of approved PV racking systems, refer to the PV Racking Compatibility document on the Enphase website at enphase.com/support.

Connector Spacing Options

IQ Cable is available in three connector spacing options. The gap between connectors on the cable can be 1.3 meters, 2.0 meters, or 2.3 meters. The 1.3 meter spacing is best suited for connecting PV modules installed in portrait orientation, while the 2.0 meter and 2.3 meter spacing allows you to install 60-cell and 72-cell PV modules in landscape orientation, respectively.

Cabling Options

Ordering options include:

Cable Model	Connector spacing	PV module orientation	Connector count per box
Q-12-10-240	1.3 m (50")	Portrait	240
Q-12-17-240	2.0 m (78")	Landscape (60-cell)	240
Q-12-20-200	2.3 m(90")	Landscape (72-cell)	200

The cabling system is flexible enough to adapt to almost any solar design. To determine the cable type you need, apply the following considerations:

- When mixing PV modules in both portrait and landscape orientation, you may need to transition between cable types. See the preceding table for available cable types.
- To transition between cable types, install a field wireable connector pair.
- In situations where portrait modules are widely spaced, you may need to use landscape spaced cables for the portrait-oriented PV modules and create loops of excess cable, if needed.



WARNING: Do not form loops smaller than 12 cm (4.75") in diameter.

Enphase IQ Cable Accessories

The Enphase IQ Cable is available with several accessory options for ease of installation, including:

- **Field wireable connectors (male):** (Q-CONN-10M) Make connections from any field wireable female connector.
- **Field wireable connectors (female):** (Q-CONN-10F) Make connections from any IQ Cable open connector or Field Wireable male connector.
- **Cable clips:** (Q-CLIP-100) Used to fasten cabling to the racking or to secure looped cabling.
- **Disconnect tool:** (Q-DISC-10) Disconnect tool for IQ Cable connectors, DC connectors, and AC module mount.
- **IQ Cable sealing caps (female):** (Q-SEAL-10) One needed to cover each unused connector on the cabling.
- **Terminator:** (Q-TERM-10) Terminator cap for cut cable ends.

Technical Data

Technical Considerations

Be sure to apply the following when installing the Enphase IQ8 Series Microinverter System:



WARNING: Risk of equipment damage. You must match the DC operating voltage range of the PV module with the allowable input voltage range of the Enphase Microinverter.



WARNING: Risk of equipment damage. The maximum open circuit voltage of the PV module must not exceed the specified maximum input voltage of the Enphase Microinverter.

- PV modules must have conductors labeled "PV Wire" or "PV Cable" to comply with NEC for Ungrounded PV Power Systems.
- Verify that the voltage and current specifications of the PV module match those of the microinverter.
- The maximum short circuit current rating of the PV module must be equal to or less than the maximum input DC short circuit current rating of the microinverter.

The output voltage and current of the PV module depend on the quantity, size and temperature of the PV cells, as well as the insolation on each cell. The highest PV module output voltage occurs when the temperature of the cells is the lowest and the PV module is at open circuit (not operating).

Bifacial Modules

Enphase Microinverters are compatible with bifacial PV modules. Bifacial solar modules produce power from both sides of a bifacial module, increasing total energy generation. The power gained from rear side (bifacial gain) is highly influenced by various design factors such as albedo, module elevation, pitch, temperature and shading. The bifacial gain can be anywhere between 0% to 30% of nominal rating (front side power rating) of the module. Since the bifacial gain is highly influenced by various design considerations, pairing the bifacial module with right microinverter depends on the electrical characteristics of a given module.

The temperature adjusted electrical parameters (maximum power, voltage and current) of the bifacial modules, considering the front side electrical parameters (i.e.0% back side gain), must be within the microinverter input parameters range.

See Step 3: Mount the Microinverters on page 15 for tips on vertical mounting of bifacial modules.

Specifications

See specifications in the following tables for:

- Enphase IQ8-60-M-US Microinverters
- Enphase IQ8PLUS-72-M-US Microinverters
- Enphase IQ8M-72-M-US Microinverters
- Enphase IQ8A-72-M-US Microinverters
- Enphase IQ8H-240-72-M-US Microinverters
- Enphase IQ8H-208-72-M-US Microinverters
- Enphase IQ Cable

IQ8-60-M-US Microinverter Specifications

Enphase IQ8-60-M-US Microinverter Parameters				
Topic	Unit	Min	Typical	Max
DC Parameters				
Commonly used modules for pairing ¹		235W – 350W		
Peak power tracking voltage	V	27		37
Operating Voltage Range	V	16		48
Maximum Input DC Voltage	V			50
Minimum/Maximum start voltage	V	22		48
Max. continuous input DC current	A			10
Max. input DC short-circuit current	A			25
Max. module I _{sc}	A			20
Overvoltage class DC port			II	
DC Port backfeed under single fault	A			0
PV array configuration	1x1 ungrounded array; No additional DC side protection required; AC side protection requires max 20A per branch circuit			
AC Parameters				
Maximum continuous AC output power	VA	240		
Peak output power	VA	245		
Grid-tied power factor (adjustable)		0.85 leading 0.85 lagging		
Nominal AC output voltage range 240 VAC (single phase) ²	V _{rms}	211		264
Max continuous output current	A		1.0	
Nominal frequency	Hz		60	
Extended frequency range	Hz	47		68
Maximum AC output over current protection device	A	20		
AC short circuit fault current over 3 cycles	A _{rms}	2		
High AC voltage trip limit accuracy	%	±1.0		
Low AC voltage trip limit accuracy	%	±1.0		
Frequency trip limit accuracy	Hz	±0.1		
Trip time accuracy (for trip times or delays < 5 sec.)	±ms			33
Trip time accuracy (for trip times or delays ≥ 5 sec.)	%			1
Overvoltage class AC port			III	
AC port backfeed current	mA	30		
Power factor setting			1.0	

Enphase IQ8-60-M-US Microinverter Parameters				
Topic	Unit	Min	Typical	Max
Miscellaneous Parameters				
Maximum4 microinverters per 20A (max) AC branch circuit 240 VAC (single phase) ³				16
CEC weighted efficiency 240 VAC (single phase)	%			97
Total harmonic distortion	%			<5
Ambient temperature range	°C	-40		+60
Night-time power consumption	mW			60
Storage temperature range	°C	-40		+85
Features and Specifications				
Compatibility	60-cell/120 half-cell PV modules			
Dimensions not including mounting bracket	212 mm (8.3") x 175 mm (6.9") x 30.2 mm (1.2")			
Connector Type	Enphase IQ™ Connector			
Weight	1.08 kg (2.38 lbs)			
Environmental Category/ UV exposure rating	NEMA Type 6 / outdoor			
Torque specifications for fasteners (Do not over torque)	<ul style="list-style-type: none"> • 6 mm (1/4") mounting hardware: 5 Nm (45 to 50 in-lbs.) • 8 mm (5/16") mounting hardware: 9 Nm (80 to 85 in-lbs.) • When using UL 2703 mounting hardware, use the manufacturer's recommended torque value 			
Cooling	Natural convection - No fans			
Relative Humidity range	4% to 100% (condensing)			
Approved for wet locations	Yes			
Pollution degree	PD3			
Standard Warranty Term	http://enphase.com/warranty			

Enphase IQ8-60-M-US Microinverter Parameters

Compliance	CA Rule 21 (UL 1741-SA), UL 62109-1, IEEE1547:2018 (UL 1741-SB), FCC Part 15 Class B, ICES-0003 Class B, CAN/CSA-C22.2 NO. 107.1-01 This product is UL Listed as PV Rapid Shutdown Equipment and conforms with NEC 2014, NEC 2017, and NEC 2020 section 690.12 and C22.1-2018 Rule 64-218 Rapid Shutdown of PV Systems, for AC and DC conductors, when installed according manufacturer's instructions.
Grounding	The DC circuit meets the requirements for ungrounded PV arrays in NEC. Ground fault protection (GFP) is integrated into the class II double insulated microinverter
Monitoring	Enphase Installer platform and Enphase App monitoring options. Both options require an Enphase IQ Gateway
Communication	Power line communication (PLC)

(1) No enforced DC/AC ratio. See the compatibility calculator at <https://link.enphase.com/module-compatibility> (2) Nominal voltage range can be extended beyond nominal if required by the utility. (3) Limits may vary. Refer to local requirements to define the number of microinverters per branch in your area.

IQ8PLUS-72-M-US Microinverter Specifications

Enphase IQ8PLUS-72-M-US Microinverter Parameters				
Topic	Unit	Min	Typical	Max
DC Parameters				
Commonly used modules for pairing ¹		235W – 440W		
Peak power tracking voltage	V	27		45
Operating Voltage Range	V	16		58
Maximum Input DC Voltage	V			60
Minimum/Maximum start voltage	V	22		58
Max. continuous input DC current	A			12
Max. input DC short-circuit current	A			25
Max. module I _{sc}	A			20
Overvoltage class DC port			II	
DC Port backfeed under single fault	A			0
PV array configuration	1x1 ungrounded array; No additional DC side protection required; AC side protection requires max 20A per branch circuit			
AC Parameters				
Maximum continuous AC output power	VA	290		
Peak output power	VA	300		
Grid-tied power factor (adjustable)		0.85 leading 0.85 lagging		
Nominal AC output voltage range 240 VAC (single phase) ²	V _{rms}	211		264
Max continuous output current	A _{rms}		1.21	
Nominal frequency	Hz		60	
Extended frequency range	Hz	47		68
Maximum AC output over current protection device	A	20		
AC short circuit fault current over 3 cycles	A _{rms}	2		
High AC voltage trip limit accuracy	%	±1.0		
Low AC voltage trip limit accuracy	%	±1.0		
Frequency trip limit accuracy	Hz	±0.1		
Trip time accuracy (for trip times or delays < 5 sec.)	±ms			33
Trip time accuracy (for trip times or delays ≥ 5 sec.)	%			1
Overvoltage class AC port			III	
AC port backfeed current	mA	30		
Power factor setting			1.0	

Enphase IQ8PLUS-72-M-US Microinverter Parameters				
Topic	Unit	Min	Typical	Max
Miscellaneous Parameters				
Maximum ⁴ microinverters per 20A (max) AC branch circuit 240 VAC (single phase) ³				13
CEC weighted efficiency 240 VAC (single phase)	%			97
Total harmonic distortion	%			<5
Ambient temperature range	°C	-40		+60
Night-time power consumption	mW			60
Storage temperature range	°C	-40		+85
Features and Specifications				
Compatibility	54-cell/108 half-cell, 60-cell/120 half-cell, 66-cell and 72-cell/144 half-cell			
Dimensions not including mounting bracket	212 mm (8.3") x 175 mm (6.9") x 30.2 mm (1.2")			
Connector Type	Enphase IQ™ Connector			
Weight	1.08 kg (2.38 lbs)			
Environmental Category/ UV exposure rating	NEMA Type 6 / outdoor			
Torque specifications for fasteners (Do not over torque)	<ul style="list-style-type: none"> 6 mm (1/4") mounting hardware: 5 Nm (45 to 50 in-lbs.) 8 mm (5/16") mounting hardware: 9 Nm (80 to 85 in-lbs.) When using UL 2703 mounting hardware, use the manufacturer's recommended torque value 			
Cooling	Natural convection - No fans			
Relative Humidity range	4% to 100% (condensing)			
Approved for wet locations	Yes			
Pollution degree	PD3			
Standard Warranty Term	http://enphase.com/warranty			

Enphase IQ8PLUS-72-M-US Microinverter Parameters

Compliance	CA Rule 21 (UL 1741-SA), UL 62109-1, IEEE1547:2018 (UL 1741-SB), FCC Part 15 Class B, ICES-0003 Class B, CAN/CSA-C22.2 NO. 107.1-01 This product is UL Listed as PV Rapid Shutdown Equipment and conforms with NEC 2014, NEC 2017, and NEC 2020 section 690.12 and C22.1-2018 Rule 64-218 Rapid Shutdown of PV Systems, for AC and DC conductors, when installed according manufacturer's instructions.
Grounding	The DC circuit meets the requirements for ungrounded PV arrays in NEC. Ground fault protection (GFP) is integrated into the class II double insulated microinverter
Monitoring	Enphase Installer Platform and Enphase App monitoring options. Both options require an Enphase IQ Gateway
Communication	Power line communication (PLC)

(1) No enforced DC/AC ratio. See the compatibility calculator at <https://link.enphase.com/module-compatibility> (2) Nominal voltage range can be extended beyond nominal if required by the utility. (3) Limits may vary. Refer to local requirements to define the number of microinverters per branch in your area.

IQ8M-72-M-US Microinverter Specifications

Enphase IQ8M-72-M-US Microinverter Parameters				
Topic	Unit	Min	Typical	Max
DC Parameters				
Commonly used modules for pairing ¹		260W – 460W		
Peak power tracking voltage	V	30		45
Operating Voltage Range	V	16		58
Maximum Input DC Voltage	V			60
Minimum/Maximum start voltage	V	22		58
Max. continuous input DC current	A			12
Max. input DC short-circuit current	A			25
Max. module I _{sc}	A			20
Overvoltage class DC port			II	
DC Port backfeed under single fault	A			0
PV array configuration	1x1 ungrounded array; No additional DC side protection required; AC side protection requires max 20A per branch circuit			
AC Parameters				
Maximum continuous AC output power	VA	325		
Peak output power	VA	330		
Power factor (adjustable)		0.85 leading 0.85 lagging		
Nominal AC output voltage range 240 VAC (single phase) ²	Vrms	211		264
Max continuous output current	Arms		1.35	
Nominal frequency	Hz		60	
Extended frequency range	Hz	47		68
Maximum AC output over current protection device	A	20		
AC short circuit fault current over 3 cycles	Arms	2		
High AC voltage trip limit accuracy	%	±1.0		
Low AC voltage trip limit accuracy	%	±1.0		
Frequency trip limit accuracy	Hz	±0.1		
Trip time accuracy (for trip times or delays < 5 sec.)	±ms			33
Trip time accuracy (for trip times or delays ≥ 5 sec.)	%			1
Overvoltage class AC port			III	
AC port backfeed current	mA	30		
Power factor setting			1.0	

Enphase IQ8M-72-M-US Microinverter Parameters				
Topic	Unit	Min	Typical	Max
Miscellaneous Parameters				
Maximum ⁴ microinverters per 20A (max) AC branch circuit 240 VAC (single phase) ³				11
CEC weighted efficiency 240 VAC (single phase)	%			97.5
Total harmonic distortion	%			<5
Ambient temperature range	°C	-40		+60
Night-time power consumption	mW			60
Storage temperature range	°C	-40		+85
Features and Specifications				
Compatibility	54-cell/108 half-cell, 60-cell/120 half-cell, 66-cell and 72-cell/144 half-cell			
Dimensions not including mounting bracket	212 mm (8.3") x 175 mm (6.9") x 30.2 mm (1.2")			
Connector Type	Enphase IQ™ Connector			
Weight	1.08 kg (2.38 lbs)			
Environmental Category/ UV exposure rating	NEMA Type 6 / outdoor			
Torque specifications for fasteners (Do not over torque)	<ul style="list-style-type: none"> • 6 mm (1/4") mounting hardware: 5 Nm (45 to 50 in-lbs.) • 8 mm (5/16") mounting hardware: 9 Nm (80 to 85 in-lbs.) • When using UL 2703 mounting hardware, use the manufacturer's recommended torque value 			
Cooling	Natural convection - No fans			
Relative Humidity range	4% to 100% (condensing)			
Approved for wet locations	Yes			
Pollution degree	PD3			
Standard Warranty Term	http://enphase.com/warranty			

Enphase IQ8M-72-M-US Microinverter Parameters

Compliance	CA Rule 21 (UL 1741-SA), UL 62109-1, IEEE1547:2018 (UL 1741-SB), FCC Part 15 Class B, ICES-0003 Class B, CAN/CSA-C22.2 NO. 107.1-01 This product is UL Listed as PV Rapid Shutdown Equipment and conforms with NEC 2014, NEC 2017, and NEC 2020 section 690.12 and C22.1-2018 Rule 64-218 Rapid Shutdown of PV Systems, for AC and DC conductors, when installed according manufacturer's instructions.
Grounding	The DC circuit meets the requirements for ungrounded PV arrays in NEC. Ground fault protection (GFP) is integrated into the class II double insulated microinverter
Monitoring	Enphase Installer App and Enphase App monitoring options. Both options require an Enphase IQ Gateway
Communication	Power line communication (PLC)

(1) No enforced DC/AC ratio. See the compatibility calculator at (2) Nominal voltage range can be extended beyond nominal if required by the utility. (3) Limits may vary. Refer to local requirements to define the number of microinverters per branch in your area.

IQ8A-72-M-US Microinverter Specifications

Enphase IQ8A-72-M-US Microinverter Parameters				
Topic	Unit	Min	Typical	Max
DC Parameters				
Commonly used modules for pairing ¹		295W – 500W		
Peak power tracking voltage	V	32		45
Operating Voltage Range	V	16		58
Maximum Input DC Voltage	V			60
Max. continuous input DC current	A			12
Max. input DC short-circuit current	A			25
Max. module I _{sc}	A			20
Overvoltage class DC port			II	
DC Port backfeed under single fault	A			0
PV array configuration	1x1 ungrounded array; No additional DC side protection required; AC side protection requires max 20A per branch circuit			
AC Parameters				
Maximum continuous AC output power	VA	349		
Peak output power	VA	366		
Power factor (adjustable)		0.85 leading 0.85 lagging		
Nominal AC output voltage range 240 VAC (single phase) ³	V _{rms}	211		264
Max continuous output current	A _{rms}		1.45	
Nominal frequency	Hz		60	
Extended frequency range	Hz	47		68
Maximum AC output over current protection device	A	20		
AC short circuit fault current over 3 cycles	A _{rms} for over 3 cycle	5.8A _{rms}		
High AC voltage trip limit accuracy	%	±1.0		
Low AC voltage trip limit accuracy	%	±1.0		
Frequency trip limit accuracy	Hz	±0.1		
Trip time accuracy (for trip times or delays < 5 sec.)	±ms			33
Trip time accuracy (for trip times or delays ≥ 5 sec.)	%			1
Overvoltage class AC port			III	
AC port backfeed current	mA	30		
Power factor setting			1.0	

Enphase IQ8A-72-M-US Microinverter Parameters				
Topic	Unit	Min	Typical	Max
Miscellaneous Parameters				
Maximum ⁴ microinverters per 20A (max) AC branch circuit 240 VAC (single phase)				11
CEC weighted efficiency 240 VAC (single phase)	%			97
Total harmonic distortion	%			<5
Ambient temperature range	°C	-40		+60
Night-time power consumption	mW			60
Storage temperature range	°C	-40		+85
Features and Specifications				
Compatibility	54-cell/108 half-cell, 60-cell/120 half-cell, 66-cell and 72-cell/144 half-cell			
Dimensions not including mounting bracket	212 mm (8.3") x 175 mm (6.9") x 30.2 mm (1.2")			
Connector Type	Enphase IQ™ Connector			
Weight	1.08 kg (2.38 lbs)			
Environmental Category/ UV exposure rating	NEMA Type 6 / outdoor			
Torque specifications for fasteners (Do not over torque)	<ul style="list-style-type: none"> 6 mm (1/4") mounting hardware: 5 Nm (45 to 50 in-lbs.) 8 mm (5/16") mounting hardware: 9 Nm (80 to 85 in-lbs.) When using UL 2703 mounting hardware, use the manufacturer's recommended torque value 			
Cooling	Natural convection - No fans			
Relative Humidity range	4% to 100% (condensing)			
Approved for wet locations	Yes			
Pollution degree	PD3			
Standard Warranty Term	http://enphase.com/warranty			

Enphase IQ8A-72-M-US Microinverter Parameters	
Compliance	<p>CA Rule 21 (UL 1741-SA), UL 62109-1, IEEE1547:2018 (UL1741-SB), FCC Part 15 Class B, ICES-0003 Class B, CAN/CSA-C22.2 NO. 107.1-01</p> <p>This product is UL Listed as PV Rapid Shutdown Equipment and conforms with NEC 2014, NEC 2017, and NEC 2020 section 690.12 and C22.1-2018 Rule 64-218 Rapid Shutdown of PV Systems, for AC and DC conductors, when installed according manufacturer's instructions.</p>
Grounding	The DC circuit meets the requirements for ungrounded PV arrays in NEC. Ground fault protection (GFP) is integrated into the class II double insulated microinverter
Monitoring	Enphase Installer Platform and Enphase App monitoring options. Both options require an Enphase IQ Gateway
Communication	Power line communication (PLC)

(1) No enforced DC/AC ratio. See the compatibility calculator at <https://link.enphase.com/module-compatibility> (2) Nominal voltage range can be extended beyond nominal if required by the utility. (3) Limits may vary. Refer to local requirements to define the number of microinverters per branch in your area.

IQ8H-240-72-M-US Microinverter Specifications

Enphase IQ8H-240-72-M-US Microinverter Parameters				
Topic	Unit	Min	Typical	Max
DC Parameters				
Commonly used modules for pairing ¹		320W – 540W		
Peak power tracking voltage	V	36		45
Operating Voltage Range	V	16		58
Maximum Input DC Voltage	V			60
Minimum/Maximum start voltage	V	22		58
Max. continuous input DC current	A			12
Max. input DC short-circuit current	A			25
Max. module I _{sc}	A			20
Overvoltage class DC port			II	
DC Port backfeed under single fault	A			0
PV array configuration	1x1 ungrounded array; No additional DC side protection required; AC side protection requires max 20A per branch circuit			
AC Parameters				
Maximum continuous AC output power	VA	380		
Peak output power	VA	384		
Power factor (adjustable)		0.85 leading 0.85 lagging		
Nominal AC output voltage range ² 240 VAC (single phase)	V _{rms}	211		264
Max continuous output current	A _{rms}		1.58	
Nominal frequency	Hz		60	
Extended frequency range	Hz	47		68
Maximum AC output over current protection device	A	20		
AC short circuit fault current over 3 cycles	A _{rms}	2		
High AC voltage trip limit accuracy	%	±1.0		
Low AC voltage trip limit accuracy	%	±1.0		
Frequency trip limit accuracy	Hz	±0.1		
Trip time accuracy (for trip times or delays < 5 sec.)	±ms			33
Trip time accuracy (for trip times or delays ≥ 5 sec.)	%			1
Overvoltage class AC port			III	
AC port backfeed current	mA	30		
Power factor setting			1.0	

Enphase IQ8H-240-72-M-US Microinverter Parameters				
Topic	Unit	Min	Typical	Max
Miscellaneous Parameters				
Maximum ⁴ microinverters per 20A (max) AC branch circuit 240 VAC (single phase)				10
CEC weighted efficiency 240 VAC (single phase)	%			97
Total harmonic distortion	%			<5
Ambient temperature range	°C	-40		+60
Night-time power consumption	mW			60
Storage temperature range	°C	-40		+85
Features and Specifications				
Compatibility	54-cell/108 half-cell, 60-cell/120 half-cell, 66-cell and 72-cell/144 half-cell			
Dimensions not including mounting bracket	212 mm (8.3") x 175 mm (6.9") x 30.2 mm (1.2")			
Connector Type	Enphase IQ™ Connector			
Weight	1.08 kg (2.38 lbs)			
Environmental Category/ UV exposure rating	NEMA Type 6 / outdoor			
Torque specifications for fasteners (Do not over torque)	<ul style="list-style-type: none"> 6 mm (1/4") mounting hardware: 5 Nm (45 to 50 in-lbs.) 8 mm (5/16") mounting hardware: 9 Nm (80 to 85 in-lbs.) When using UL 2703 mounting hardware, use the manufacturer's recommended torque value 			
Cooling	Natural convection - No fans			
Relative Humidity range	4% to 100% (condensing)			
Approved for wet locations	Yes			
Pollution degree	PD3			
Standard Warranty Term	http://enphase.com/warranty			

Enphase IQ8H-240-72-M-US Microinverter Parameters

Compliance	CA Rule 21 (UL 1741-SA), UL 62109-1, IEEE1547:2018 (UL1741-SB), FCC Part 15 Class B, ICES-0003 Class B, CAN/CSA-C22.2 NO. 107.1-01 This product is UL Listed as PV Rapid Shutdown Equipment and conforms with NEC 2014, NEC 2017, and NEC 2020 section 690.12 and C22.1-2018 Rule 64-218 Rapid Shutdown of PV Systems, for AC and DC conductors, when installed according manufacturer's instructions.
Grounding	The DC circuit meets the requirements for ungrounded PV arrays in NEC. Ground fault protection (GFP) is integrated into the class II double insulated microinverter
Monitoring	Enphase Installer Platform and Enphase App monitoring options. Both options require an Enphase IQ Gateway
Communication	Power line communication (PLC)

(1) No enforced DC/AC ratio. See the compatibility calculator at <https://link.enphase.com/module-compatibility> (2) Nominal voltage range can be extended beyond nominal if required by the utility. (3) Limits may vary. Refer to local requirements to define the number of microinverters per branch in your area.

IQ8H-208-72-M-US Microinverter Specifications

Enphase IQ8H-208-72-M-US Microinverter Parameters				
Topic	Unit	Min	Typical	Max
DC Parameters				
Commonly used modules for pairing ¹		295W – 500W		
Peak power tracking voltage	V	36		45
Operating Voltage Range	V	16		58
Maximum Input DC Voltage	V			60
Minimum/Maximum start voltage	V	22		58
Max. continuous input DC current	A			12
Max. input DC short-circuit current	A			25
Max. module I _{sc}	A			20
Oversvoltage class DC port			II	
DC Port backfeed under single fault	A			0
PV array configuration	1x1 ungrounded array; No additional DC side protection required; AC side protection requires max 20A per branch circuit			
AC Parameters				
Maximum continuous AC output power	VA	360		
Peak output power	VA	366		
Power factor (adjustable)		0.85 leading 0.85 lagging		
Nominal AC output voltage range ³ 208 VAC	Vrms	183		229
Max continuous output current	Arms		1.73	
Nominal frequency	Hz		60	
Extended frequency range	Hz	47		68
Maximum AC output over current protection device	A	20		
AC short circuit fault current over 3 cycles	Arms	4.4		
High AC voltage trip limit accuracy	%	±1.0		
Low AC voltage trip limit accuracy	%	±1.0		
Frequency trip limit accuracy	Hz	±0.1		
Trip time accuracy (for trip times or delays < 5 sec.)	±ms			33
Trip time accuracy (for trip times or delays >= 5 sec.)	%			1
Oversvoltage class AC port			III	
AC port backfeed current	mA	30		
Power factor setting			1.0	

IQ8/IQ8+/IQ8M/IQ8A/IQ8H Microinverter Installation and Operation

Enphase IQ8H-208-72-M-US Microinverter Parameters				
Topic	Unit	Min	Typical	Max
Miscellaneous Parameters				
Maximum ⁴ microinverters per 20A (max) AC branch circuit 208 VAC				9
CEC weighted efficiency 208 VAC	%			97
Total harmonic distortion	%			<5
Ambient temperature range	°C	-40		+60
Night-time power consumption	mW			60
Storage temperature range	°C	-40		+85
Features and Specifications				
Compatibility	54-cell/108 half-cell, 60-cell/120 half-cell, 66-cell and 72-cell/144 half-cell			
Dimensions not including mounting bracket	212 mm (8.3") x 175 mm (6.9") x 30.2 mm (1.2")			
Connector Type	Enphase IQ™ Connector			
Weight	1.08 kg (2.38 lbs)			
Environmental Category/ UV exposure rating	NEMA Type 6 / outdoor			
Torque specifications for fasteners (Do not over torque)	<ul style="list-style-type: none"> 6 mm (1/4") mounting hardware: 5 Nm (45 to 50 in-lbs.) 8 mm (5/16") mounting hardware: 9 Nm (80 to 85 in-lbs.) When using UL 2703 mounting hardware, use the manufacturer's recommended torque value 			
Cooling	Natural convection - No fans			
Relative Humidity range	4% to 100% (condensing)			
Approved for wet locations	Yes			
Pollution degree	PD3			
Standard Warranty Term	http://enphase.com/warranty			

Enphase IQ8H-208-72-M-US Microinverter Parameters

Compliance	CA Rule 21 (UL 1741-SA), UL 62109-1, IEEE1547:2018 (UL 1741-SB), FCC Part 15 Class B, ICES-0003 Class B, CAN/CSA-C22.2 NO. 107.1-01 This product is UL Listed as PV Rapid Shutdown Equipment and conforms with NEC 2014, NEC 2017, and NEC 2020 section 690.12 and C22.1-2018 Rule 64-218 Rapid Shutdown of PV Systems, for AC and DC conductors, when installed according manufacturer's instructions.
Grounding	The DC circuit meets the requirements for ungrounded PV arrays in NEC. Ground fault protection (GFP) is integrated into the class II double insulated microinverter
Monitoring	Enphase Installer Platform and Enphase App monitoring options. Both options require an Enphase IQ Gateway
Communication	Power line communication (PLC)

(1) No enforced DC/AC ratio. See the compatibility calculator at <https://link.enphase.com/module-compatibility> (2) Nominal voltage range can be extended beyond nominal if required by the utility. (3) Limits may vary. Refer to local requirements to define the number of microinverters per branch in your area. (5) The IQ8H-208 variant will be operating in grid-tied mode only at 208V AC

IQ Cable Specifications

Specification	Value
Voltage Rating	600V
Voltage withstand test (kV/1min)	AC 3.0
Max DC conductor resistance (20°C) (Ω /km)	5.433
Insulation resistance (20°C)	$\geq 20M$ (Ω /Km)
System temperature range (ambient)	-40°C to +65°C (-40°F to 149°F)
Cable temperature rating	90°C Dry / 90°C Wet
Cable rating	DG
Certification	UL3003, TC-ER equivalent
Flame test rating	FT4
Cable conductor insulator rating	THHN/THWN-2
Environmental protection rating	IEC 60529 IP67NEMA 6
UV resistance	720h
Compliance	RoHS, OIL RES I, CE, UV Resistant, combined UL for Canada, and United States
Conductor size	12 AWG
Maximum loop size	12 cm (4.75 ")
Flat cable dimensions	6 mm x 9.5 mm (0.2" x 0.37")
Sealing cap dimensions	38.6 mm x 20 mm (1.5" x 0.7")
Cable connector dimensions	20 mm x 1.1 mm x 6.5 mm (0.7" x 0.04" x 0.25")

Enphase Connector Ratings

Enphase Connectors on the cable assemblies in the following table have a maximum current of 20 A, a maximum OCPD of 20 A, and maximum ambient temperature of -40° to +79° C (-40° to +174.2° F) and are rated for disconnection under load

Part Number	Model	Maximum Voltage
840-00387	Q-12-10-240	277VAC
840-00388	Q-12-17-240	277VAC
840-00389	Q-12-20-200	277VAC
840-00385	Q-DCC-2	100VDC
840-00386	Q-DCC-5	100VDC

Enphase Installation Map

To Sheet / A la hoja de:

Panel Group/Grupo de los paneles: Azimuth/Azimuth: Tilt/Inclinación: Sheet/Hoja _____ of/de _____		Customer/Cliente:					Installer/Instalador:		N S E W N S E O
1	2	3	4	5	6	7			
A									
B									
C									
D									
E									
F									
G									
H									
J									
K									
L									
M									

To Sheet / A la hoja de:

Scan completed map and upload it to Enphase. Click "Add a New System" at <https://enlighten.enphaseenergy.com>. Use this map to build the virtual array in Enlighten's Array Builder.

Escanee el mapa completo y cárguelo en Enphase. Haga clic en "Añadir nuevo sistema" en <https://enlighten.enphaseenergy.com>. Utilice este mapa para crear el conjunto de paneles virtual en el Creador de conjuntos de paneles de Enlighten.

Envoy Serial Number Label /
Número de serie de Envoy

To Sheet / A la hoja de:

Sample Wiring Diagram

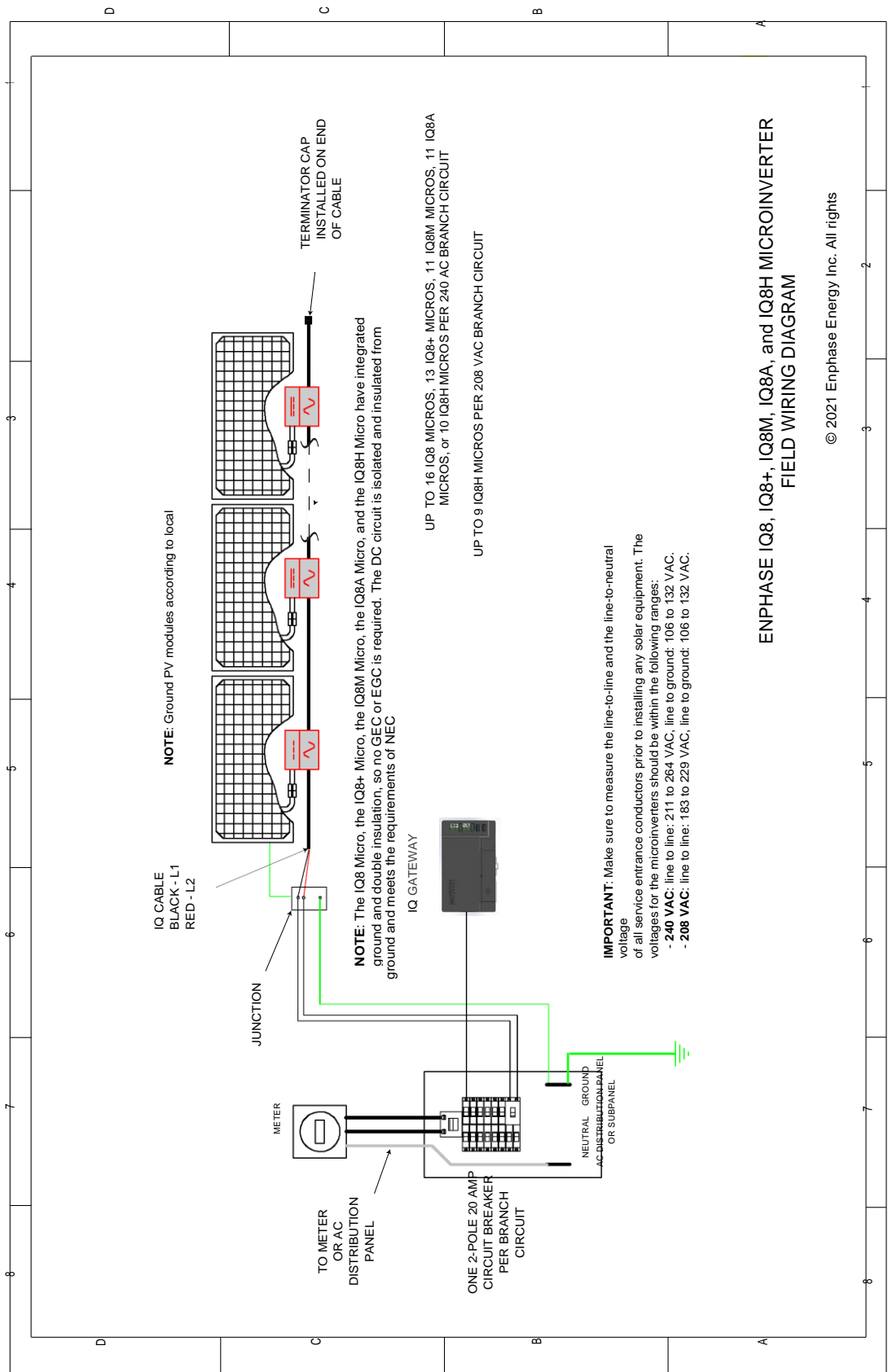

ENPHASE IQ8, IQ8+, IQ8M, IQ8A, and IQ8H MICROINVERTER
FIELD WIRING DIAGRAM

© 2021 Enphase Energy Inc. All rights reserved.